

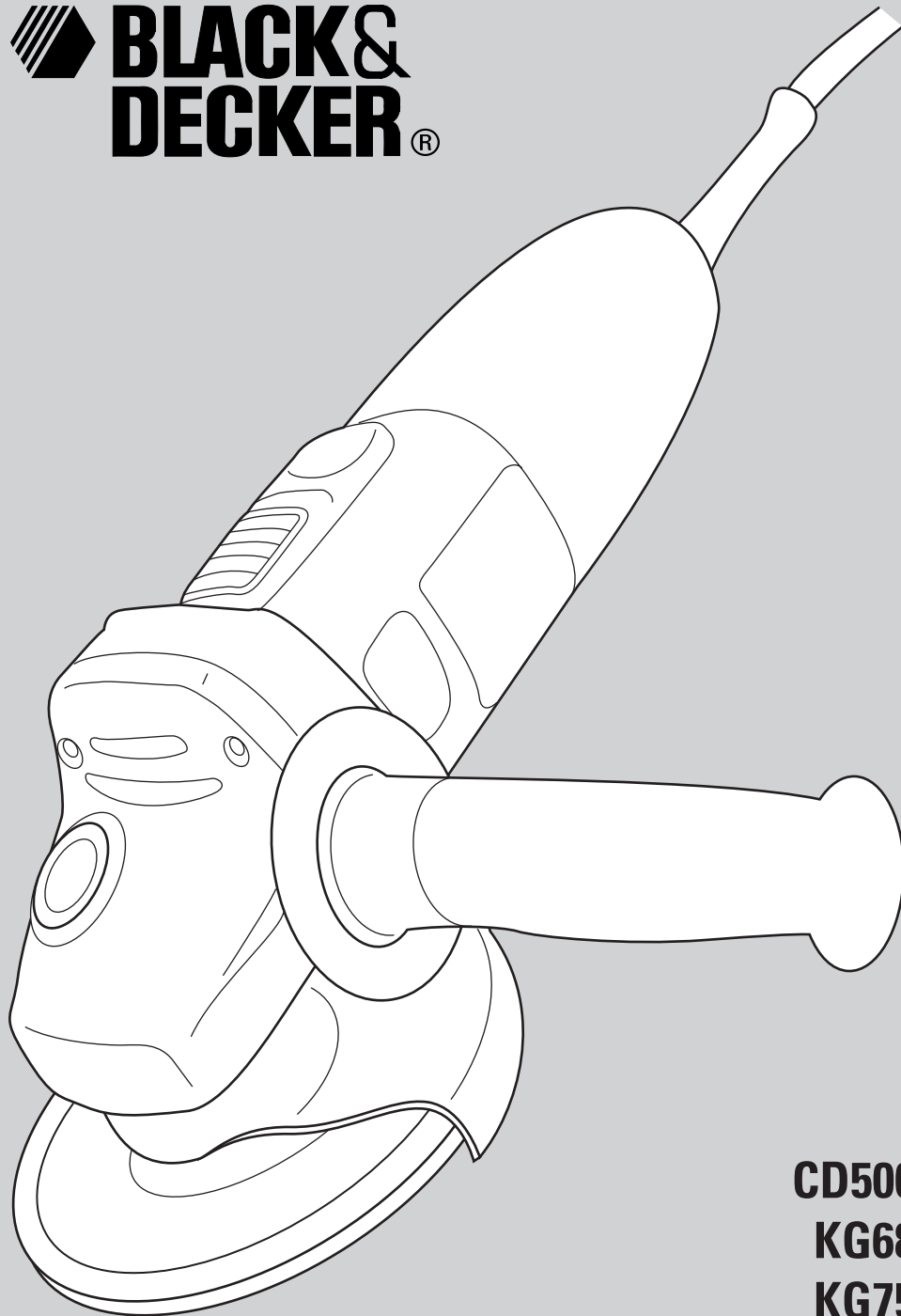

 **BLACK &  
DECKER**®



**CD500  
KG68  
KG75**





## **Congratulations!**

*On the purchase of your  
Black & Decker small angle  
grinder.*

To ensure the best results from your small angle grinder please read these safety and usage instructions carefully. If you have any questions or queries after reading this manual please do not hesitate to call your local service and information centre (the number is towards the back of this manual).





# Contents

- Page 4** Safety instructions  
Additional safety instructions for small angle grinders
- Page 5** Double insulation  
Electrical safety  
Mains plug replacement  
Extension cables  
Unwanted tools and the environment  
The Black & Decker guarantee
- Page 6** After sales service for your Black & Decker product  
Our after sales service policy  
Accessories  
Technical data  
Features  
Operating your angle grinder  
Fitting the wheel guard  
Fitting the discs
- Page 7** Removing the wheel guard  
Fitting abrasive discs
- Page 8** Handy hints  
Overload  
Tool care  
Cleaning  
EC declaration of conformity  
Black & Decker phone numbers and addresses  
Guarantee card



# Small angle grinder user manual

## SAFETY INSTRUCTIONS

**Warning!** When using electric tools, the following basic safety precautions should always be taken to reduce the risk of fire, electric shock and personal injury.

Read all these instructions before attempting to operate this product and save these instructions.

### For safe operation:

- We recommend that you take appropriate measures for the protection of hearing if the sound pressure of 85 dB (A) is exceeded.
- **Keep the work area clean.** Cluttered areas and benches invite injuries.
- **Consider work area environment.** Do not expose power tools to rain and do not use power tools in damp or wet locations. Keep the work area well lit. Do not use power tools where there is a risk to cause fire or explosion.
- **Guard against electric shock.** Avoid body contact where possible with earthed or grounded surfaces (e.g. pipes, radiators, ranges, refrigerators).
- **Keep children away.** Do not let visitors touch the tool or extension cord. All visitors should be kept away from work area.
- **Store idle tools.** When not in use, tools should be stored in a dry, high or locked place, out of reach of children.
- **Do not force the tool.** It will do the job better and more safely at the rate for which it was intended.
- **Use the right tool.** Do not force small tools or attachments to do the job of a heavy duty tool. Do not use tools for purposes not intended; for example, do not use a circular saw to cut tree limbs or logs.
- **Dress properly.** Do not wear loose clothing or jewellery as they can be caught in moving parts. Rubber gloves and non-skid footwear are recommended when working outdoors. Wear protective hair covering to contain long hair.
- **Use safety glasses.** Use a face or dust mask as well if the operation is dusty or if using in enclosed spaces.
- **Do not abuse the cord.** Never carry the tool by its cord or yank it to disconnect it from the socket. Keep the cord away from heat, oil and sharp edges.
- **Secure your work.** Use clamps or a vice to hold your work. It is safer than using your hand and it frees both hands to operate the tool.
- **Do not overreach.** Keep proper footing and balance at all times.
- **Maintain tools with care.** Keep cutting tools sharp and clean for better and safer performance. Follow instructions for lubricating and changing

accessories. Inspect tool cords periodically and if damaged have repaired by an authorised service facility. Inspect extension cords periodically and replace if damaged. Keep handles dry, clean and free from oil and grease.

- **Disconnect tools.** Disconnect when not in use, before servicing and when changing accessories such as blades, bits and cutters.
- **Remove adjusting keys and wrenches.** Form the habit of checking to see that keys and adjusting wrenches are removed from the tool and replaced in the storage area before switching on.
- **Avoid unintentional starting.** Do not carry a plugged-in tool with a finger on the switch. Ensure the switch is off when plugging in.
- **Use outdoor extension cords.** When a tool is used outdoors, use only extension cords intended for outdoor use and so marked.
- **Stay alert.** Watch what you are doing. Use common sense. Do not operate tools when you are tired.
- **Connect dust extraction equipment.** If devices are provided for the connection of dust extraction and collection facilities, ensure these are connected and properly used, especially in confined areas.
- **Check damaged parts.** Before further use of the tool, a guard or other part that is damaged should be carefully checked to determine whether it will operate properly and perform its intended function. Check for alignment of moving parts, free running of moving parts, breakage of parts, mounting and any other conditions that may affect its operation. A guard or other part that is damaged should be properly repaired or replaced by an authorised service centre unless otherwise indicated in this instruction manual. Have defective switches replaced by an authorised service centre. Do not use the tool if the switch does not turn it on and off.
- **Warning!** The use of any accessory or attachment, other than recommended in this instruction manual, may present a risk of personal injury.
- **Have your tool repaired by a qualified person.** This electrical tool is in accordance with the relevant safety requirements. Repairs should only be carried out by qualified persons using original spare parts, otherwise this may result in considerable danger to the user.

## ADDITIONAL SAFETY INSTRUCTIONS FOR SMALL ANGLE GRINDERS

- Use the guard and ensure it is fitted correctly.



## ENGLISH

- Check mounting flanges and the disc are correctly fitted and are undamaged.
- Ensure you are using the correct size and type of disc for the task.
- Ensure the disc, wire brush and sanding accessories are rated in excess of the spindle rpm of your angle grinder. Allow a newly assembled wheel to idle off-load for 30 seconds before starting any operation.

### Save these instructions!

#### DOUBLE INSULATION



Your tool is double insulated. This means that all the external metal parts are electrically insulated from the mains power supply. This is done by placing insulation barriers between the electrical and mechanical components making it unnecessary for the tool to be earthed. Note: Double insulation does not take the place of normal safety precautions when operating this tool. The insulation system is for added protection against injury resulting from a possible electrical insulation failure within the tool.

#### ELECTRICAL SAFETY

Be sure your supply is the same as the voltage given on the rating plate. This tool is fitted with a two-core cord and plug.

#### MAINS PLUG REPLACEMENT (UK ONLY)

Should the mains plug need replacing and you are competent to do this, proceed as instructed below. If you are in doubt, contact a Black & Decker service repair agent or a qualified electrician.

- Disconnect the plug from the power supply.
- Cut off the plug and dispose of safely. A plug with bared copper conductors is very dangerous if engaged in a live socket outlet.
- Only fit BS1363A approved plugs fitted with the correctly rated fuse. **Note:** Fuses do not give personal protection against electric shock.
- The cable wire colours, or a letter, will be marked at the connection point of most good quality plugs. Attach the wires to their respective points in the plug (see diagram). Brown = L (live), blue = N (neutral).
- Before replacing the top cover of the plug ensure that the cable restraint is holding the outer sheath of the cable firmly and that the two leads are correctly fixed at the terminal screws.
- Your product is supplied with a non-rewireable plug, if the fuse cover is missing or damaged do not use the plug.

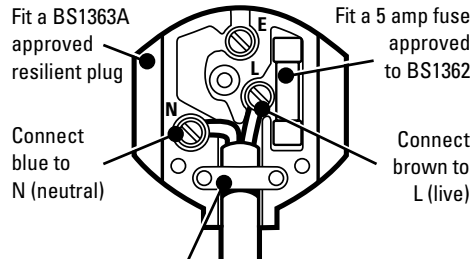

Make sure that the outer sheath of the cable is held firmly by the clamp



230 volts AC only  
Never use a light socket

**Warning!** Never connect live or neutral wires to the earth pin marked E or  $\perp$ .

#### AUSTRALIA AND NEW ZEALAND ONLY

Should the mains plug or cordset of this equipment be damaged it must only be replaced by an authorised Black & Decker service agent as special purpose tools are required.

#### EXTENSION CABLES

You can use up to 30m (100ft) of Black & Decker 2-core extension cable (or 3-core extension cable in Australia and New Zealand) without undue loss of power.

**Note:** An extension cable should not be used unless absolutely necessary. Use of an improper extension cable could result in a risk of fire and electric shock. If an extension cable must be used, make sure it is properly wired and in good electrical condition.

#### UNWANTED TOOLS AND THE ENVIRONMENT



Should you find one day that the tool needs replacement or is of no further use, think of the protection of the environment. Black & Decker service agents will accept old tools and will dispose of them in an environmentally safe way.

#### THE BLACK & DECKER GUARANTEE (UK, AUSTRALIA AND NEW ZEALAND ONLY)

If your Black & Decker product becomes defective due to faulty materials and workmanship, within 24 months from the date of purchase, we guarantee to either replace all defective parts or at our discretion, replace the unit free of charge provided that:

- The product is returned to us or our authorised repairers with evidence of date of purchase.
- The product has not been used for trade, professional or hire purposes.





# ENGLISH

- The product has not been subjected to misuse or neglect.
- The product has not sustained any damage through foreign objects, substances or accidents.
- Repairs have not been attempted by anyone other than our authorised repair distributors.

This guarantee is offered as an extra benefit and is additional to your statutory rights.

### AFTER SALES SERVICE FOR YOUR BLACK & DECKER PRODUCT (UK, AUSTRALIA AND NEW ZEALAND ONLY)

Black & Decker offers a nationwide network of authorised service agents. The use of other than genuine Black & Decker accessories and parts may damage or reduce the performance of your Black & Decker product and may also endanger the user. The terms and conditions of the warranty may also be effected.

### OUR AFTER SALES SERVICE POLICY (UK, AUSTRALIA AND NEW ZEALAND ONLY)

It is our aim that all Black & Decker customers should be totally satisfied with their Black & Decker product and after sales service, but if help or advice is needed please contact a local Black & Decker authorised repair agent manager who will be happy to help. Full details of our unique after sales service can be obtained from any of our Black & Decker authorised repair agents.

### ACCESSORIES

The performance of any power tool is dependent upon the accessory used. Black & Decker accessories are engineered to high quality standards and are designed to enhance the performance of the power tool. Buying a Black & Decker accessory will ensure that you get the very best from your Black & Decker power tool. Black & Decker accessories available include metal and stone cutting discs, grinding discs, wire brushes and sanding discs.

### TECHNICAL DATA

The level of sound pressure of this tool is in accordance with EEC legislation. You must wear ear protection when using this tool.

	CD500	KG68	KG75
Disc diameter	115mm	115mm	115mm
Power input	680W	680W	750W
No load speed	10,000rpm	10,000rpm	10,000rpm
Spindle size	M14	M14	M14
Cable length	2m	3m	3m

### FEATURES

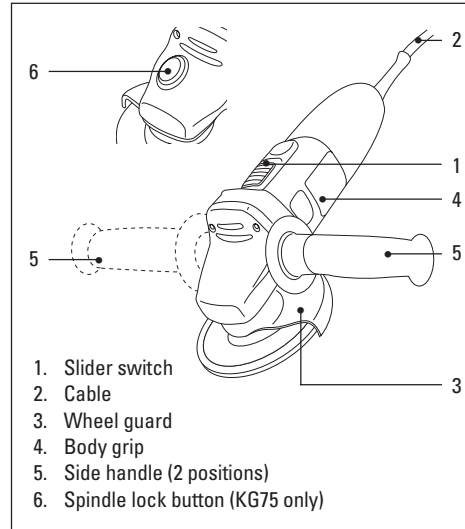

### OPERATING YOUR ANGLE GRINDER

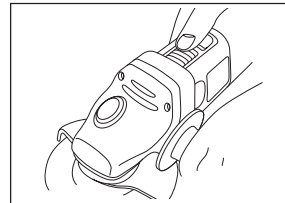

To switch your angle grinder on, push the slider switch forward. To switch your angle grinder off, press the rear of the slider switch.

Spring action returns the switch to the off position.

### FITTING THE WHEEL GUARD

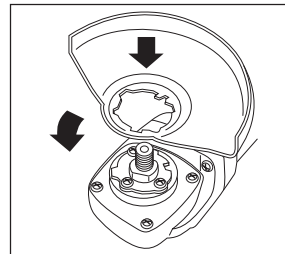

Place the angle grinder on a table, spindle up. Align the lug with the slot in the bracket. Press the guard down and turn it in the direction of the arrow.

**Note:** The guard locking pin prevents the guard from coming loose.

### FITTING THE DISCS

#### Grinding and finishing

Use a rigid abrasive disc with a depressed centre for surface grinding and finishing. The maximum diameter



# ENGLISH

disc you can use is 115mm. The maximum thickness is 6mm and the centre hole is 22mm.

### Cutting metal

Use a cutting disc for cutting rod, pipe and metal section. The maximum diameter you can use is 115mm. The maximum thickness is 3.5mm and the centre hole is 22mm.

### Cutting masonry

Use a flat cutting disc. The maximum diameter you can use is 115mm. Always approach the work at the angle at which you will cut. Maintain this angle throughout the cut and do not exert a side load on the disc.

Proceed as follows:

Disconnect the plug from the electricity supply.

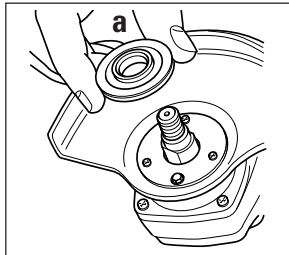

Ensure the guard is fitted. Place the inner flange (a) on the spindle. Ensure it is located on the two flats.

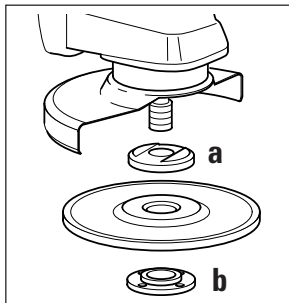

Place the abrasive disc on the spindle and inner flange (a). Ensure it is correctly located.

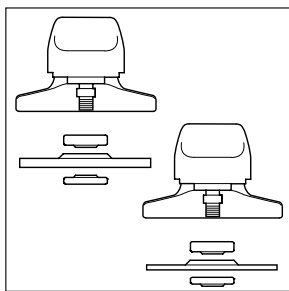

Fit the threaded outer flange (b), making sure it is facing in the correct direction for the type of disc fitted. For grinding discs, the flange (b) is fitted with the raised portion facing towards the disc. For cutting discs, the flange (b) is fitted with the inner portion facing away from the disc.

towards the disc. For cutting discs, the flange (b) is fitted with the inner portion facing away from the disc.

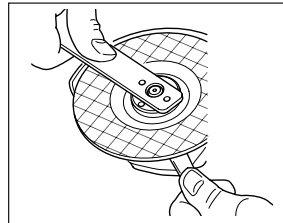

Hold the spanner on the flats of the spindle to prevent rotation of the disc and tighten the outer flange with the spanner provided.

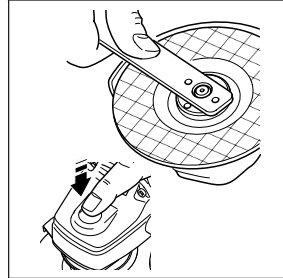

**KG75 only:** Press in the spindle lock button and rotate the spindle until it locks. Keeping the lock button pressed in, tighten the outer flange with the spanner provided.

### REMOVING THE GUARD (SANDING ONLY)

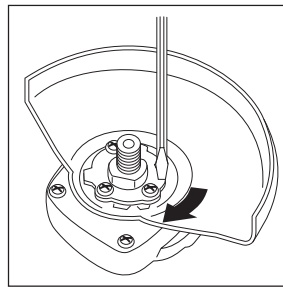

Hold the tool in your hand. Rotate the guard in the direction of the arrow. Use a screwdriver to press the locking pin in the slot. Release the guard.

### FITTING SANDING DISCS

Use a sanding disc with the backing pad for sanding with your angle grinder.

Disconnect the plug from the electricity supply.

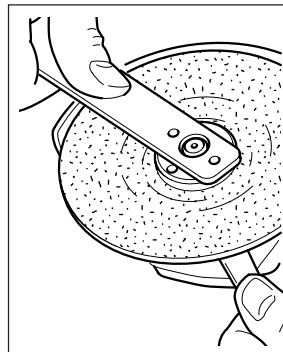

Remove the guard. Place the flange on the spindle. Place the backing pad on the spindle and inner flange, ensuring it is correctly located. Mount the fibre backed abrasive disc on the backing pad.



## ENGLISH

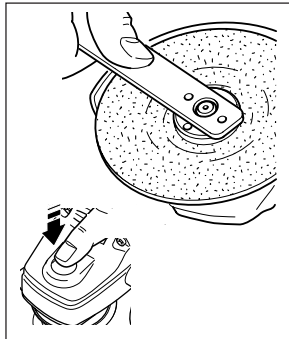

Fit the threaded outer flange and tighten as explained in 'Fitting the discs'.

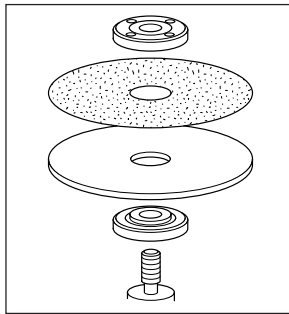

### HANDY HINTS

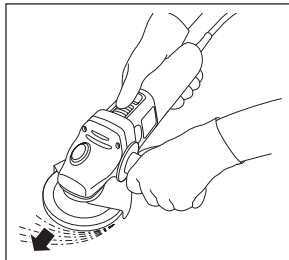

Hold your angle grinder firmly with one hand around the side handle and the other around the body of your angle grinder.

- Always position the guard so that as much of the exposed disc as possible is pointing away from you.
- Be prepared for a stream of sparks when the disc touches the metal.

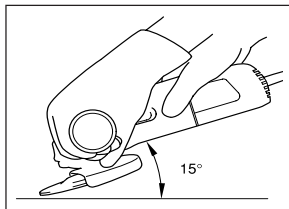

When grinding, always maintain the correct angle between the disc and the work surface (15°). This increases the removal capacity of the disc and avoids unnecessary overloading.

### OVERLOAD

Overloading will cause damage to the motor of your angle grinder. This can happen if your angle grinder is subjected to heavy duty use for prolonged periods of use. Do not in any circumstances, attempt to exert too much pressure on your angle grinder to speed up your work. The abrasive discs operate more efficiently when a light pressure is exerted, thus avoiding a drop in the speed of your angle grinder (see Tool care).

### TOOL CARE

Keep guards, air vents and the motor housing as clear as possible of dust and dirt. Wipe with a clean cloth and blow through with a low-pressure air supply. Excessive build-up of metal dust can cause tracking of electrical current from the internal parts to exposed metal parts. Do not overload your angle grinder. Overloading causes a reduction in speed and efficiency, causing your angle grinder to become too hot. If this happens, operate your angle grinder under no load for one or two minutes until it has cooled to normal operating temperature. Switching your angle grinder off under load will reduce the life of the switch.

### CLEANING

Use only mild soap and a slightly damp cloth to clean your angle grinder. Many household cleaners contain chemicals which could seriously damage the plastic. Also, do not use petrol, turpentine, lacquer or paint thinners or similar products. Never let any liquid get inside the tool and never immerse any part of the tool into liquid.

### EC DECLARATION OF CONFORMITY

We declare that units: **CD500, KG68, KG75** conform to 98/37/EEC, 89/336/EEC, EN55014, 73/23/EEC, EN50144, EN61000

A weighted sound pressure 89.9dB (A)

A weighted sound power 102.9dB (A)

Hand/arm weighted vibration <2.5m/s<sup>2</sup>

Brian Cooke - Director of Engineering  
Black & Decker Ltd, Spennymoor, County Durham  
DL16 6JG United Kingdom

The Black & Decker policy is one of continuous improvement to our product and as such we reserve the right to change the product specification without prior notice.





**BLACK & DECKER**

**KG68 KG75 CD500**

TYP.  
1

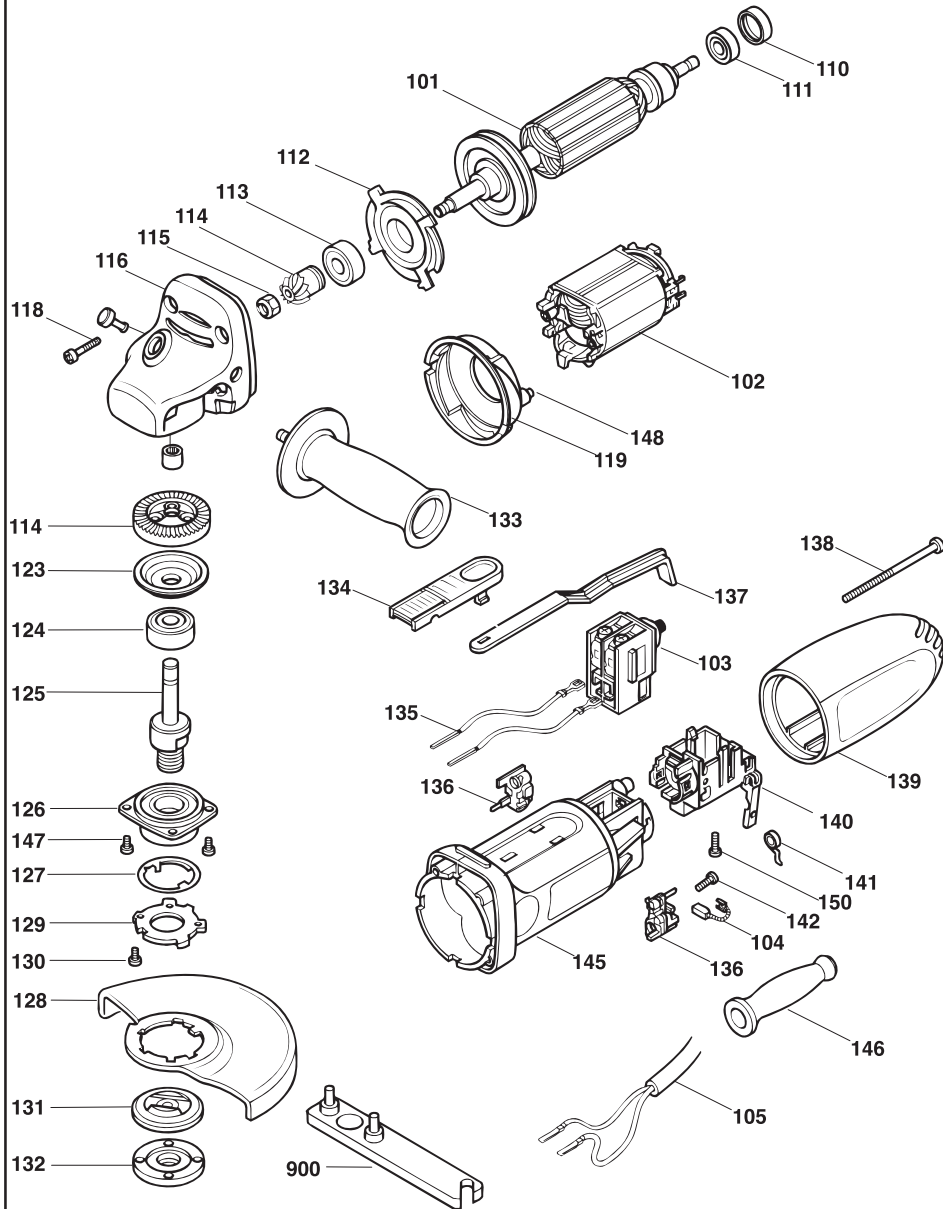

E12822

[www.2helpU.com](http://www.2helpU.com)

21 - 09 - 99 CW





<b>Australia</b>	DeWalt Industrial Power Tool Company (Distributors of Black & Decker products) 7 Clarice Road, Box Hill, Victoria 3128	Tel: 03 9895 9200 Fax: 03 9899 7465
<b>New Zealand</b>	Black & Decker 483 Great South Road Penrose, Auckland	Tel: 09 579 7600 Fax: 09 579 8200
<b>South Africa</b>	Black & Decker South Africa (Pty) Ltd Suite no 107, PostNet X65 Halfway House 1685	Tel: 011 314 4431 Fax: 011 314 4435
<b>United Kingdom</b>	Black & Decker 210 Bath Road, Slough Berkshire SL1 3YD	Tel: 01753 574277 Tlx: 848317 BAND MH Fax: 01753 551155





Address of the dealer where your angle grinder was purchased:

Date of your purchase:



Name: \_\_\_\_\_

House number or name and street: \_\_\_\_\_

Town: \_\_\_\_\_

County or state: \_\_\_\_\_

Postcode: \_\_\_\_\_

Country: \_\_\_\_\_

Product catalogue number: \_\_\_\_\_

Yes No

Was your angle grinder a gift?

Was your angle grinder your first purchase?

Was your angle grinder bought as a replacement?

What was the price of your angle grinder? \_\_\_\_\_

Address of the dealer where your angle grinder was purchased:

\_\_\_\_\_

\_\_\_\_\_

\_\_\_\_\_

**Data protection act:** Tick this box if you prefer **not** to receive information from Black & Decker or other companies.





## GUARANTEE CARD

**Australia:** Call 1900 937766 (the maximum call charge is \$2.00 excluding tax)

**New Zealand:** Call 0900 97766 (the maximum call charge is \$2.00 excluding tax)

**South Africa:** Black & Decker South Africa (Pty) Ltd, Suite no 107, PostNet X65, Halfway House 1685

**United Kingdom & Ireland:** PO Box 821, Slough, Berkshire, SL1 3AR



Please complete this section immediately after the purchase of your angle grinder and post it to the Black & Decker address in your country (above).

If you live in Australia or New Zealand, please register your purchase by phone.

